

OMSCHRIJVING
Opklapschaar met regelbare drukveer

UITVOERING
staal vernikkeld

CODE
4200-9725

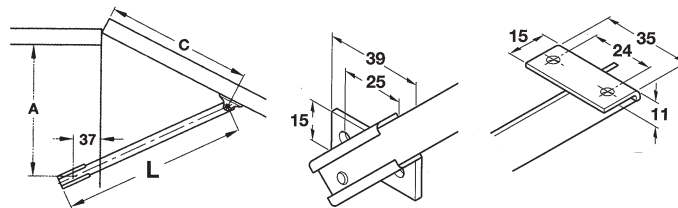
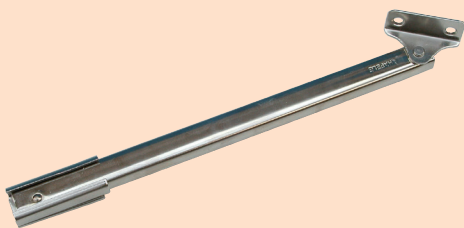
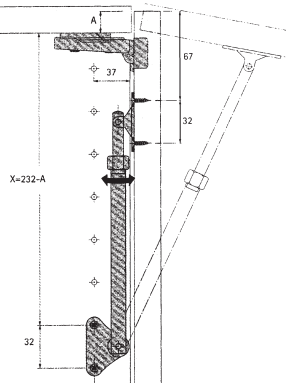

Opklapschaar met stop

OMSCHRIJVING	L	KASTDIEPTE	A	UITVOERING	CODE
opklapschaar	200 mm	210 mm	150 mm	staal vernikkeld	4205-0720
C te kennen via proefmontage	250 mm	260 mm	180 mm	staal vernikkeld	4205-0725
	300 mm	310 mm	230 mm	staal vernikkeld	4205-0730

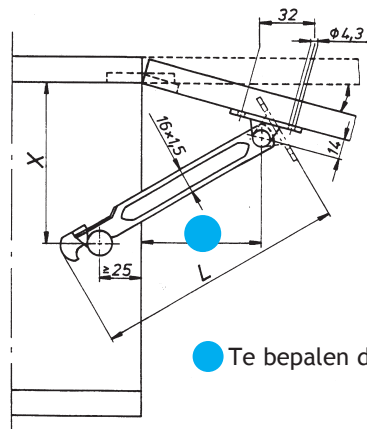

Opklapschaar om op te schroeven

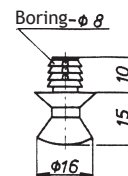

● Te bepalen door een test.

BINNENHOOGTE (H)	L	X	UITVOERING	CODE
Min. 200 mm	207	125	vernikkeld/ wit kunststof	4205-1721
Afstootknop met drevel, diam. 8 mm				4205-1728

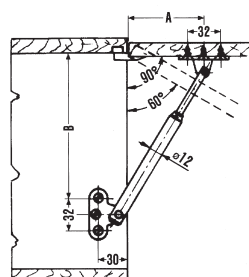
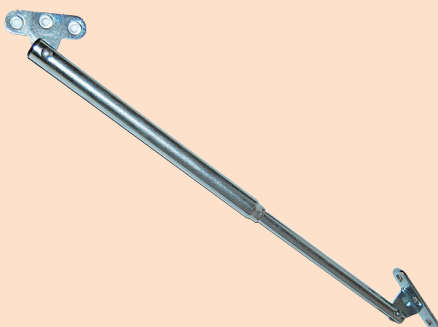

Opklapschaar

BINNENHOOGTE (H)	DIAM.	A	B	UITVOERING	CODE
Min. 200 mm	12	130	280	vernikkeld	4205-1700